

A Cryptic Quintuplet

*You must be sound of mind to uncover the key,
And based on your tone, you'll be fine, you see,
Your knowledge suffices, and so on that note,
Be in tune with the cryptics and that's all she wrote.*

- (1) Make DHH lose Knysna children!
- (2) The one who plays Necrodancer endlessly? That way!
- (3) Speaking as relative outsiders, which way is Harvard Medical School?
- (4) Early signs of automation game are current? That is extremely small!
- (5) I'm Course 2?

(1) (1) (1)' (2) (3) (4) (5) (1) (5) (4)

_____ B ____ S

— — —

The ET Parity Test

*Eight properties hold for the Thetans below,
 Each one, for each person, is one or zero,
 The initial condition has initials in mind,
 The second, if them in the name you can find.
 The third and the fourth query status, you see,
 But one academic, and one at ET,
 The fifth and the sixth ask for length of the name,
 One simple and one with comparing, I claim.
 The seventh thinks if you are sorted, that's great.
 The eighth's dictionary asks you: "early or late?"
 Once all of these rules you completely deduce,
 An ultimate answer you will need to produce.
 For one, it's a DETAILED QUESTION, IN RETROSPECT.
 You can use this advice if you do so elect.
 What's more, it's CONCEALED BY ANDY WILLFULLY.
 With that, I hope you can solve this most skillfully.*

XYZ	Yinzhan Xu		0	1	1		1	1	1
JA	Joshua Ani		1		0		1		1
AAA	Adam Atanas			1	0	0		1	
AYS	Yan Sheng Ang		0	1		1	1		
MC	Matthew Cho		1			0	1	0	1
VLB	Victor Luo	1	0				1		1
BAC	Ben Chang		0				0	0	0
KT	Katharin Tai	0		1	1	1			
JY	Jason Ye					0	1		1
HER	Helen Read	1	1	0		0			
AAH	Andy Haupt		0				0	1	0
ALT	Andy Tockman				1	1			0
ABK	Andrey Khesin	1	0		1				0
SPAN	Span Spanbauer	0	1	1			0		
DHH	Dylan Hendrickson	1				1		1	
ASA	Hizami Anuar	1		0	1			0	0
LH	Linus Hamilton	0	1						
EW	Ellen Wang		1	0				1	
MG	Meghal Gupta		1	0	0			0	
IXA	Ixa Gani				1	0	0		0
JB	Josh Brunner	0			0		0	0	
JAMB	Jackie Bredenberg	0				1			1
M2W	Mollie Wilkinson		0		0	1		0	
BR	Brian Reinhart		1	0	0		0	1	0

Untangle My Spaghetti!

*This factory's layout is awful, oh gosh!
Who on Earth left the planning to Jason and Josh?
These paths are all scrambled, so how will I know,
The order things entered this mess from below?
And if through these conveyors, your composure you've held,
You'll find that the answer's an insect misspelled.*



Battery

*This is a fun puzzle, please don't be a grouch,
Though you're tired of hearing these sounds from the couch,
It's the game where you move, though you stay in your seat,
By pressing some arrows and all on the beat.
Before you's a task for the bravest daredevil,
Crypt of the Necrodancer full custom level.
Each weapon you see can be used only once,
Leave a monster alive, and then you'll be the dunce,
So mark the whole strike zone, rub your hands with glee,
For then the big picture you will start to see.*

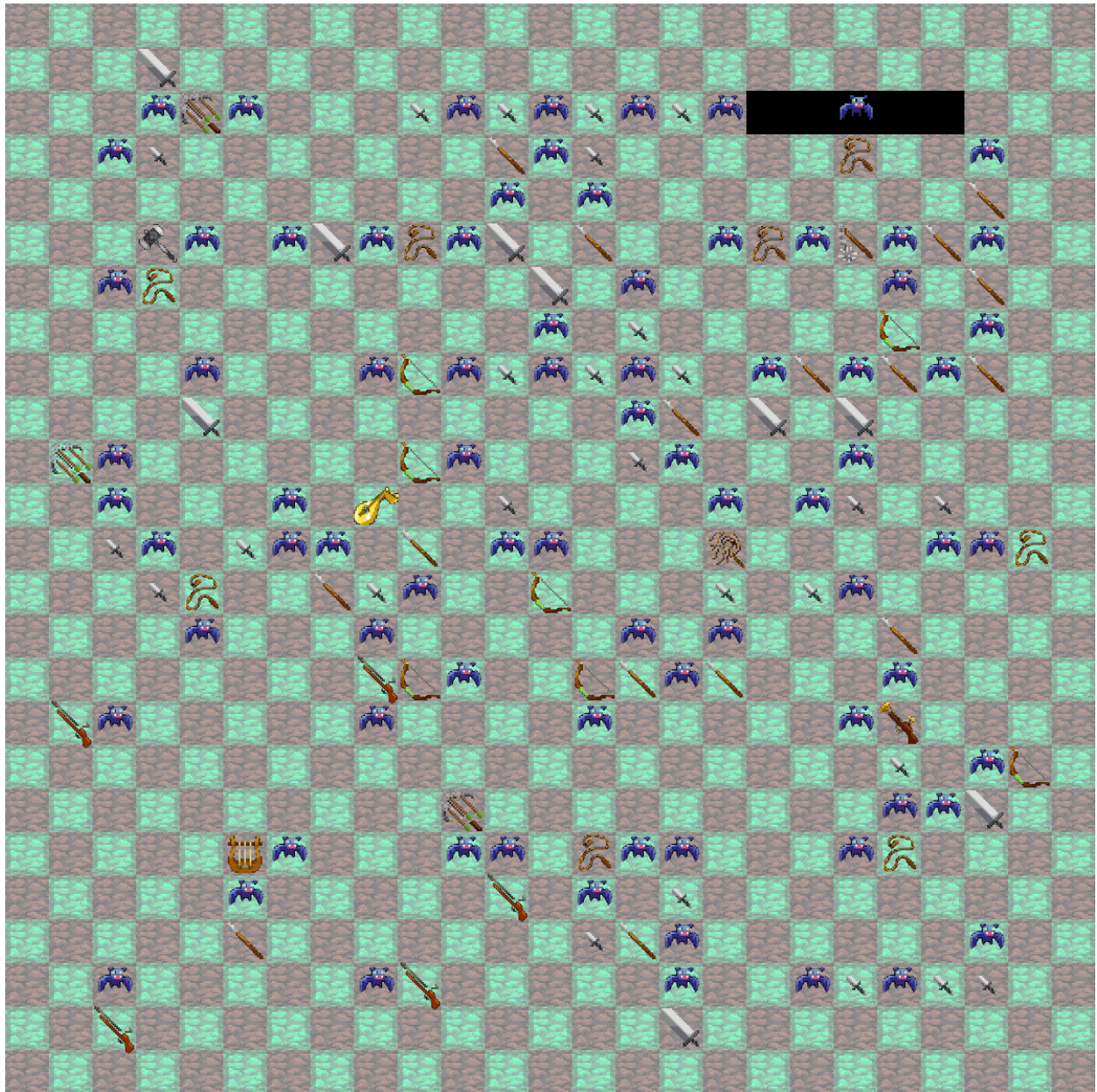

Minionry

*“Ding! Ding! Ding!” goes the timer, time for Minions to start,
Sending shockwaves of fear through our dear Jackie’s heart,
But not everyone’s horrified at this buzzer’s chime,
Python’s planning and plotting on enemy time.
He’s creating a game where you’ll be shocked to find,
The mechanics of Minions and Tichu combined!
Where any one card beats the one that’s three greater,
And going out sooner is better than later.
But while you’re all caught up in your Tichu mood,
On Python’s turn Meghal has had time to brood,
A Bughouse of Minions game forms from the dust,
And please don’t object or cry out in disgust.
Money lets you buy pieces to drop on the board,
For their cost in pawns, if it you can afford,
Checkmate in one, and one more thing to learn,
Like Minions, you can move each piece on your turn.
And if you’re having doubts for which pieces to buy,
You should take a good look at what you can supply.*



1

2

4

1

27

9

256

?

K Q R B N P

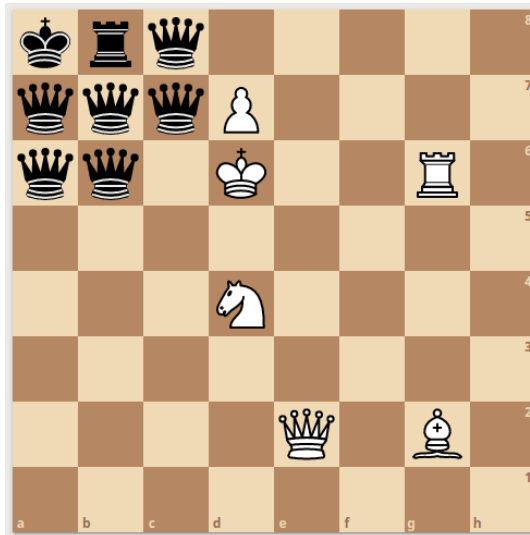
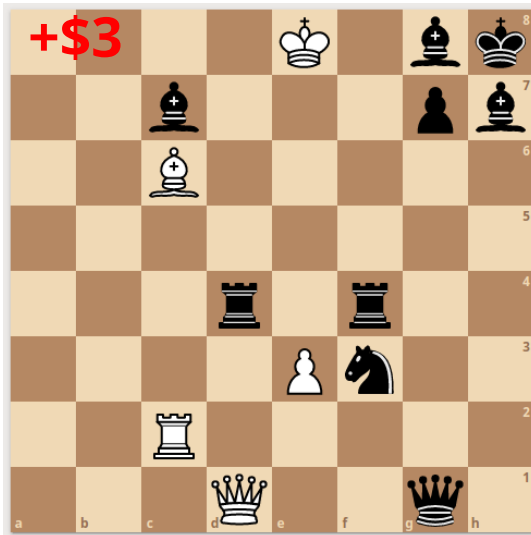
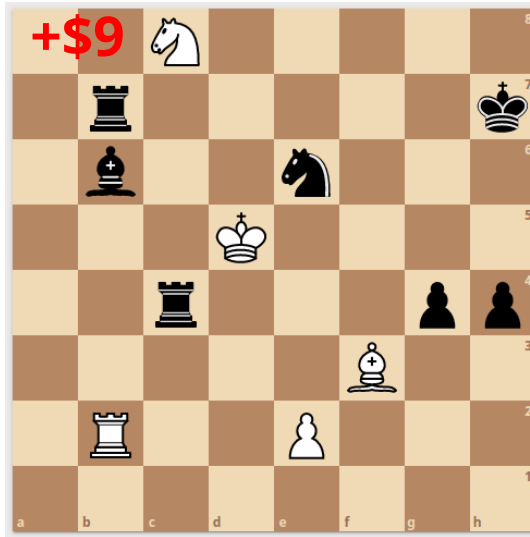
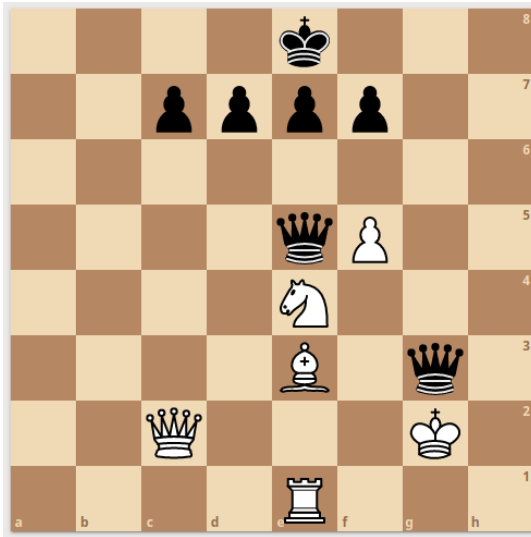

shIny Jack-o-Lantern Meta



Cryptic of the NECROMANCER

*Flavour text and titles can be used to help you solve,
But not every puzzle will truly these involve.
Like here if you solve the cryptics that I have used,
You will then find your friends albeit braised and confused.*

bishop resorts to a ship (4)
dabangg actor khanna has a french wine overdose (5)
first stray should be searched for (6)
friend adjusted apple folder browser (6)
how to finish game of wit, original humour, and ends of gig? (4, 2)
most file before first cunning hogwarts caretaker (5)
old pal ate weird tailless vermin (8)
possesses legumes that sound past their best (3, 5)
put money on rag we organised (5)
register rain to be weird (8)
stops before five, sent packing (8)
time charming woman gets spasm (6)
what's cast by artist who says what to eat (9)
wisconsin town street first pond (5, 4)

20 12 19 2 16 6 9
12 2 11 13 13 9 20 20
13 4 5 20 9
15 11 19 20 12
20 2 11 1
6 19 2 3 9
13 11 3 9 20
(15 11 3 9)

Shoot the Star Right and Left Grand Square Through Four Ladies CHAIN Down the Lines Forward and Back Track

*ANDY and DYLAN, since they had the means,
Decided to play a game of "Sardines",
Find all the words that have all found your friends,
And then you'll be able to tie up LOOSE ENDS.*

C R C E A C W S T E C
H A P H I H C A N D Y
N R H O I O O P D K N
R O A S T C O P Y O M
E R K C S O K L L O S
W E H R A L T E A B I
Y T C R E A M T N A P
H A E Z R T G O O S E
N W I D B E T W O O R
Y R R E B L L U B S D
P K L I M F R Y B S E

A _ _ _ _	M _ _ _ _
B _ _ _ _	M _ _ K
B _ _ K	M _ _ _ _
B _ _ _ _ _	P _ N
B _ _ _ _	P _ T
B _ _ _ _ _	P _ _ _ _
C _ _ _ _	R _ _ _ _
C _ _ _ _ _ _	S _ _ _ _ _
C _ _ _ _ _ _ _ _	S _ _ _ _
C _ O _	S _ _ _ _
C _ _ _ _ _	T _ A
F _ _ _	W _ _ _ _ _
G _ _ _ _ _	W _ _ _ _ _ _ _

_ _ _ _ _

The Witness

*If I want to stay true to the style of the game,
This flavour text's already extra, I claim.*

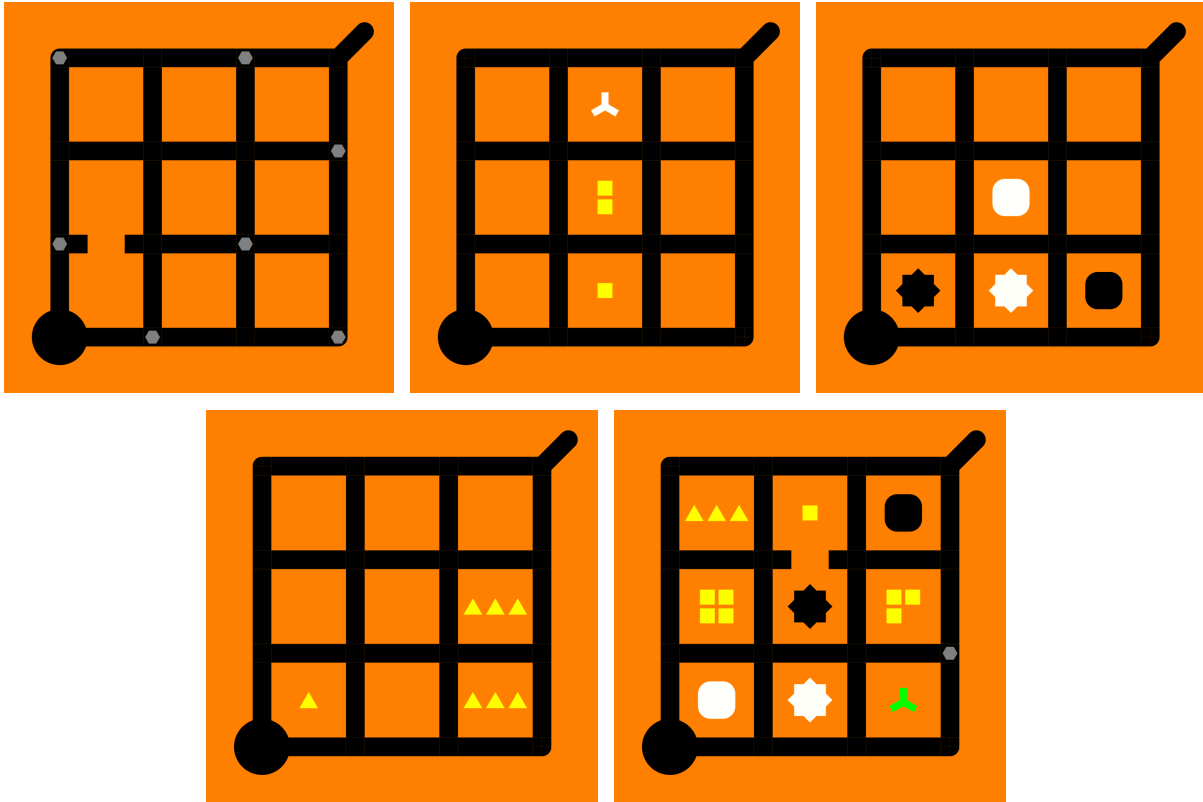

Who You Gonna Call?

*The theme to this puzzle the pledges have seen,
It's much like their costumes for this Halloween,
I won't reveal more in these rhymes here today,
For fear I'll say something which gives it away.*

Ball

Flags

Wonders

Stars

Bears

Canada

Lives

— — — — —

Whoa, We're Halfway There, Whoa-Oh

For each picture you see in this three by three box,
 Find a string to inscribe in the table of blocks,
 Take the two words you extract out of those,
 And find what sits right and with each of them goes.

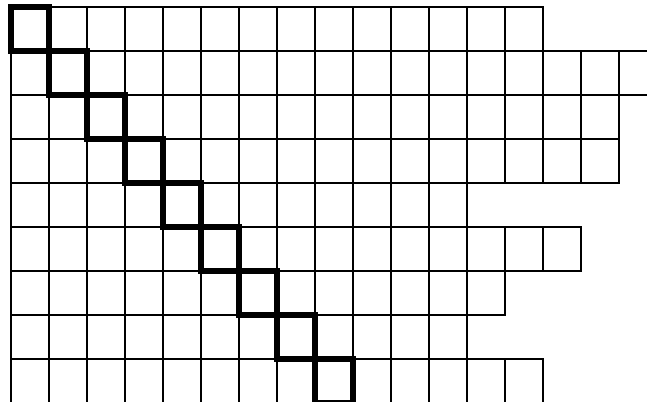
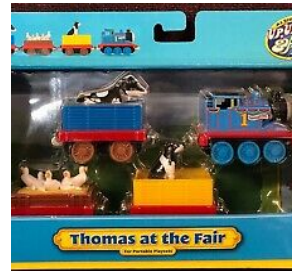
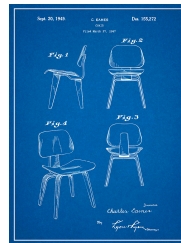

GIRL CROUCHES on a TIGHTROPE because a
BOARD is haunted by GHOSTS

*There is a number that is magic,
I claim that number's seventeen,
And I say frankly, it's quite tragic,
That some this magic have not seen.
So start with magic for word one,
With each word on until you're done,
Assign one more than what you passed,
Do well and twenty one is last.
Raise all of them to the fifth power,
Take mod by double magic too,
The words' diagonal you view,
ROT those five letters at this hour,
By each row's value, and I claim,
That the result should form a name.*

— — — — —

Izquierda Ilegal

*I think there is nada I need to write here,
I claim los instructions son perfectly clear.*

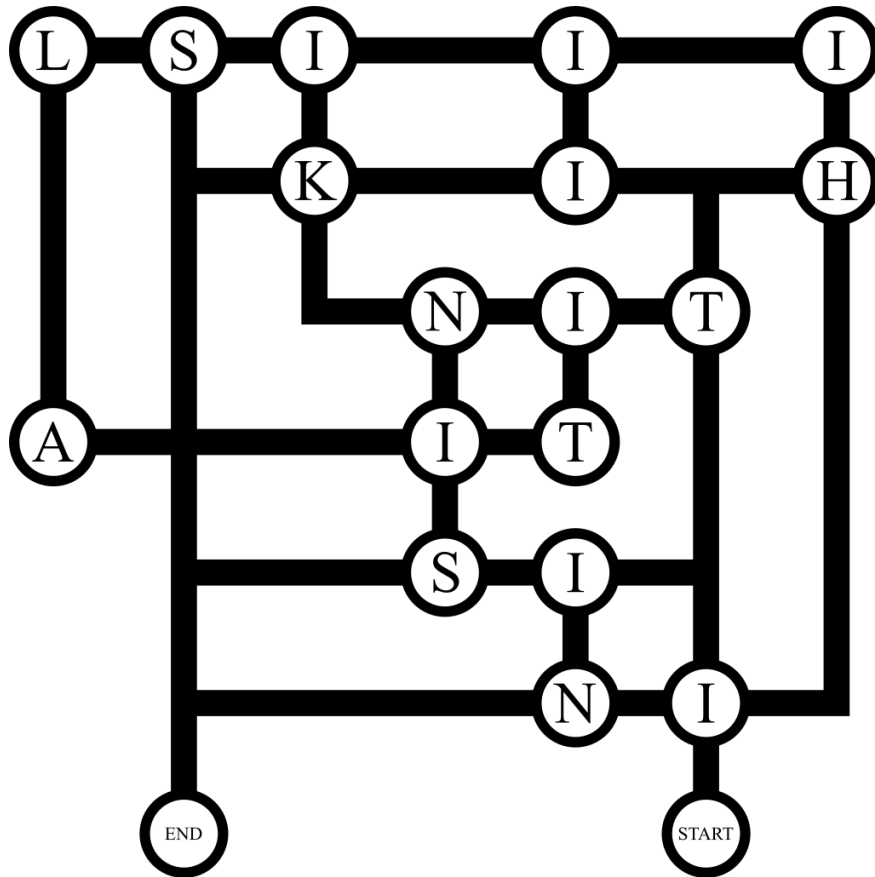

No Nuts November

*Welcome my friend and aspiring cook,
Here's everything you have to do by the book,
For each set of people, I kindly entreat,
With two things below, cook a dish they can eat.
The rest of the things that the dish will contain,
Everyone loves and no one will complain,
The rest of the meal as prepared by your team,
Already appeased all requests for a theme.*

	Eggs	Milk	Onions	Fish	Peanuts	Pork
Beef	A	B	C	D	E	F
Bell peppers	G	H	I	J	K	L
Chickpeas	M	O	P	Q	R	S
Spice	T	U	V	W	X	Y

ABK, AYS, JAMB, JB
BAC, JA, JY, M2W
ASA, IXA, JAMB, VLB
DHH, JB, M2W, SPAN
AAA, ALT, DHH, JA

Property P

*A great deal is known about Property P,
Go two centuries back, and I'd disagree,
Back then mathematicians would have said to your face,
1 has Property P. That's no longer the case.*

A	B	C	D	E
F	G	H	I	J
K	L	M	N	O
Q	R	S	T	U
V	W	X	Y	Z

- A) Intersections with traffic lights on route of regular 17R van
- B) Letters missing in Epsilon Theta plaque in main hallway
- C) Years since Saint Paul Upgrades and Renovations
- D) Points to check on Pest Control Inspection Log
- E) Moose signs in Aaron Fink Memorial library
- F) Light bulbs in room with checkerboard floor
- G) Paragraphs in The Tale of Jimmy & Tommy
- H) Faces on 2009 composite, counting repeats
- I) Amelia, Nanowave Hypercomputer buttons
- J) Racks/levels in Dumbledoor (incl. bottom)
- K) Thetans pictured in 2016 fall retreat photo
- L) Days of activities in (open) 2019 fall rush
- M) Regular rolls equivalent to 15 Scott rolls
- N) Height of shortest 2013 pledge in inches
- O) Second floor doors (not emergency exit)
- Q) Couches and armchairs on ground floor
- R) Articles in By-Laws of ET Fraternity
- S) Helmets on bookshelf with helmets
- T) Ducks on mirror in Women's Plus
- U) Komala (the Pokémon) plushies
- V) Total steps on stairs in ET
- W) Fridges/freezers in ET
- X) ET Phone Home
- Y) It's A Trap!
- Z) Tichu score

Typo Text Tree Traversal

*Andrey likes plant stems and ambushing prey,
Corner likes the lightest of all shades of gray,
Katharin likes woodwinds, or so I allege,
Ixa likes a sharp knife and its cutting edge,
Meghal stares angrily, sometimes at you,
Victor likes 60 when playing Osu!,
If you make a Word Ladder through the Big-Little tree,
Then what Alwina Liu likes you will quickly see.*

Unreplaceable UwU

*I extract each line below from a famous OP-ED,
 In the chart the first glyph of each source I embed,
 In some other cells you will find I've described,
 Some words from Beyoncé, rephrased and transcribed.
 But if somehow my message you still can't decrypt,
 You should ask someone else—or just learn the script!*

					1			2	D
		3							
					B		4		
	5							A	
			C						

- 1) On a particular sunny day, a happiness greater than magic will pour down endlessly.
 - 2) Ring out; shall I name this heart-rending pain “snow halo”?
 - 3) Are you the food? No, we are the hunters!
 - 3) Like a cruel angel, young boy, become the legend!
 - 4) Don't stop us now, the moment of truth; we were born to make history!
 - 5) Please don't say you are “lazy,” because you're actually crazy.
- C) Tell me, please tell me, how does this arrangement work? Who is there inside me?

A B C D C"

Meta Morphism

@all8 #circulate

*If you want to have a chance,
To solve this puzzle, you should dance,
And having done so, you should write,
Two of three names from left to right.*

Heads watch how the sides promenade halfway,
Allemande left with your corner now you just may,
Swing your partner when you get back home once more,
Heads go up to the middle and square through four.
Touch a quarter in front of you, isn't that's a fun move,
All eight circulate around to get in your groove,
Girls trade with each other while the boys just wait,
Split circulate twice, isn't square dancing great?
Half sashay your partner, the girls go in front,
All eight circulate, well that's a fancy stunt,
Pass the ocean, make a wave, and if we're agreed,
Extend then will give you the formation that you need.